

Представитель в России:
ООО «ПО ИП»
Тел: +7 (812)602-77-08
E-mail: info@poip.ru
www.poip.ru

SIMASV[®]

🇮🇹 Prodotti realizzati utilizzando le presse piegatrici orizzontali SIMASV[®]
🇬🇧 Products realized working with SIMASV[®] horizontal bending presses



PRESSE PIEGATRICI ORIZZONTALI

MIGLIORA IL TUO LAVORO CON UNA PRESSA PIEGATRICE ORIZZONTALE SIMASV®

Avete la necessità di ottenere dei particolari diversi, accurati anche con materiali "difficili", da applicare a strutture complesse?

La soluzione è semplice: basta affidarsi ad una pressa piegatrice idraulica orizzontale SIMASV®!

SOLIDITA'

Le presse piegatrici idrauliche orizzontali SIMASV® si distinguono innanzitutto per la solidità complessiva della struttura, essenzialmente data da:

- una rigida struttura monoblocco
- un carrello molto robusto su guide interne solide e rigide
- perni in acciaio speciale con inserto conico a gioco "0" per eliminare ogni flessione
- adeguate protezioni da caduta pezzi o materiali in collisione

La struttura delle presse SIMASV® **non flette** durante le lavorazioni assicurando un risultato di alta precisione e grande cura.

PRECISIONE

I modelli dotati di controllo CN (serie DIGIT) supportano l'operatore nell'impostazione della più stringente accuratezza millimetrica ed infinita ripetibilità.

Le stesse innumerevoli attrezzature, in dotazione e optional, oltre ad avere una grande robustezza, consentono un'ampia varietà di lavorazioni con un'unica pressapiegatrice.

Basti pensare alla possibilità di installare un sistema a punzonare e/o una curvatrice a due posizioni con comando indipendente:

- per lavorare tubi e profili tondi, per arricciare e attorcigliare
- per ottenere curvature di grandi raggi e profili speciali.

VERSATILITA'

Garantendo la qualità e l'intercambiabilità delle attrezzature, una pressa piegatrice SIMASV® rappresenta un investimento duraturo nel tempo e proficuo per la vostra attività.

PROFESSIONALITA'

La rete di vendita SIMASV®, formata da personale commerciale e tecnico scelto, vi guida professionalmente nella scelta del macchinario e del corredo di attrezzature adatte alle vostre necessità di lavorazione.

S.I.M.A.S.V. è inoltre in grado di risolvere le problematiche particolari di lavorazione che vorrete sottoporre fornendo attrezzature e macchinari speciali progettati e fabbricati on demand.

Per maggiori informazioni potete pertanto:

- contattare il Vostro rivenditore di fiducia oppure
- rivolgervi direttamente al costruttore S.I.M.A.S.V.
mailto: marketing@simasv.it.

BREVETTI

Dispositivo di bloccaggio rapido dei perni conici portapunzoni e portamatrici con punzoni e matrici intercambiabili nelle pressepiegatrici orizzontali

L'invenzione riguarda un dispositivo di bloccaggio rapido dei perni conici portapunzoni e portamatrici con punzoni e matrici intercambiabili che consente di ridurre sensibilmente il tempo necessario per la sostituzione di detti utensili sulle presse orizzontali fornendo nel contempo la massima sicurezza nell'uso della macchina

HORIZONTAL BENDING PRESSES

IMPROVE YOUR WORK WITH A SIMASV® HORIZONTAL BENDING PRESS

Do you need to get different and accurate metal pieces, to be applied to complex structures, even if you use hard material?

The solution is simple: you only need to rely on a SIMASV® horizontal hydraulic bending press!

SOLIDITY

SIMASV® hydraulic horizontal bending presses distinguish themselves for the overall solidity of their structure, featured by:

- a rigid monobloc structure
- a very solid carriage on solid and hard internal slides
- special steel pins with conical insert with clearance "0" eliminating every flexion
- suitable protections against fall of materials or materials in collision

The structure of SIMASV® bending presses **does not flex** during the working process and therefore ensures highly precise and accurate results.

PRECISION

CN models (DIGIT series) help the operators in setting the most millimetric strict accuracy and endless repeatability.

The same great number of tools, standard or optional, besides being very durable, allows a wide range of metal workings with a single bending press. Just consider the possibility of mounting a punching unit and/or a two-position ring roller system with independent control:

- for making the traditional round tubes and profiles and to curl and twist
- for large radius bending and special profiles.

VERSATILITY

Since it guarantees the quality and the interchangeability of the working tools, a SIMASV® bending press represents a profitable and long lasting investment for your business.

PROFESSIONALISM

SIMASV® sale network, composed by selected sale and technical people, can assist you with professionalism in the choice of the most suitable machine-tool and the relevant equipment.

S.I.M.A.S.V. can also solve the peculiar metalworking problems you would like to draw to our attention, by supplying toolings and special machines, designed and manufactured on demand.

For further information you are welcome

- to get in touch with your local supplier or
- to contact directly the manufacturing company S.I.M.A.S.V.
mailto: marketing@simasv.it

PATENTS

Punch- and die-carrier conical pin rapid locking device with interchangeable punches and dies in bending machines

A punch- and die-carrier conical pin rapid locking device with interchangeable punches and dies, considerably reducing the substitution time of these bending press tools, while providing the greatest level of safety in the use of the machine

SIMASV® GREEN TECHNOLOGY

SIMASV®, da sempre attenta alle tematiche ambientali e all'utilizzo dei più avanzati criteri di qualità nella costruzione di macchine utensili, è lieta di informare la rispettabile clientela di aver dotato tutta la gamma delle **presse orizzontali** del sistema **GREEN TECHNOLOGY**.

Risparmio di energia e rispetto dell'ambiente, un binomio necessario per essere al passo con i tempi e per consentire agli utilizzatori delle presse SIMASV di sfruttare razionalmente le risorse minimizzando l'uso dell'energia.

Il sistema **GREEN TECHNOLOGY**, controllando lo spegnimento della vostra pressa nei momenti di temporaneo inutilizzo e con la possibilità di selezionare il tempo d'intervento, otterrà per voi tre immediati vantaggi:

- Risparmio energetico del 20% ca. in funzione delle modalità di utilizzo della macchina;
- Utilizzo razionale del motore con garanzia di maggiore vita utile;
- Minore calore dissipato dal motore ed impianto elettrico ottimizzato nelle correnti prelevate.

Per maggiori informazioni Vi preghiamo di contattare l'Ufficio Commerciale di S.I.M.A.S.V. (inviare una email a: marketing@simasv.it).

SIMASV® GREEN TECHNOLOGY

SIMASV®, which has always been attentive to environmental issues and the use of the most advanced quality standards in the manufacture of its machine tools, is pleased to announce that its entire range of **horizontal bending presses** has been equipped with a **GREEN TECHNOLOGY** system.

Energy savings and environmental protection, a combination that's necessary in order to keep pace with the times, as well as to allow the users of SIMASV® presses to efficiently exploit their resources while at the same time minimizing energy consumption.

By shutting off the bending press during temporary disuse, and by offering the possibility of selecting the delay time, the **GREEN TECHNOLOGY** system offers three immediate advantages:

- Energy savings of up to 20% based on the machine's mode of operation;
- Efficient motor use, ensuring an extended service life;
- Less heat dissipated by the motor and optimised current consumption by the electrical system.

For more information, please contact the S.I.M.A.S.V. Sales Office directly. (mail to: marketing@simasv.it).



**green
technology** by SIMASV®

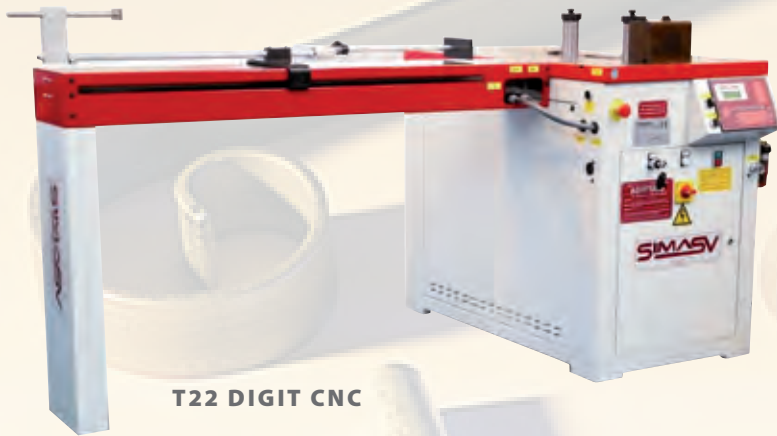

T22 DIGIT CNC



T40 DIGIT CNC



T22



T100 DIGIT CNC



T40



T22 CHAMALEON



T120

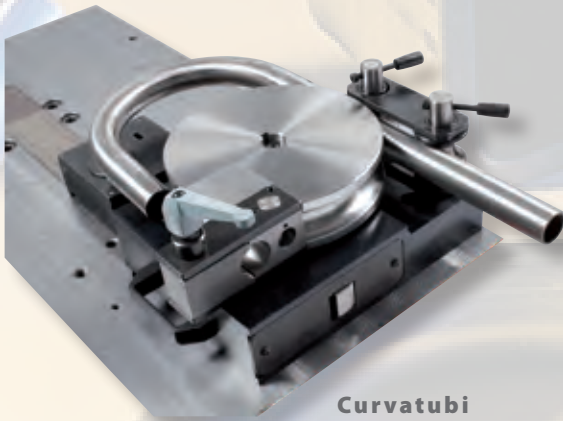

Curvatubi
Pipe bending

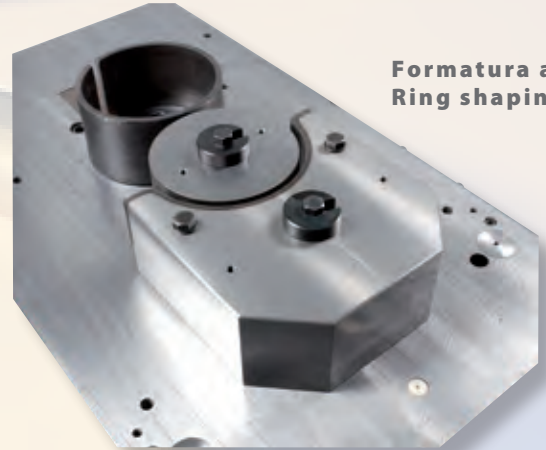

Formatura anelli
Ring shaping



Formatura spirali
Spiral shaping

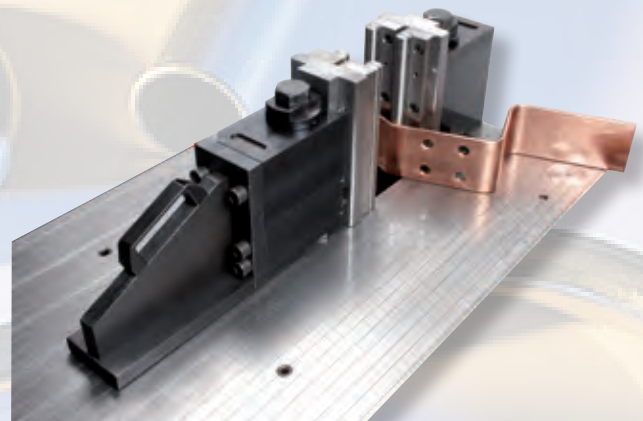

Piegatura BUS BARS
BUS BARS bending

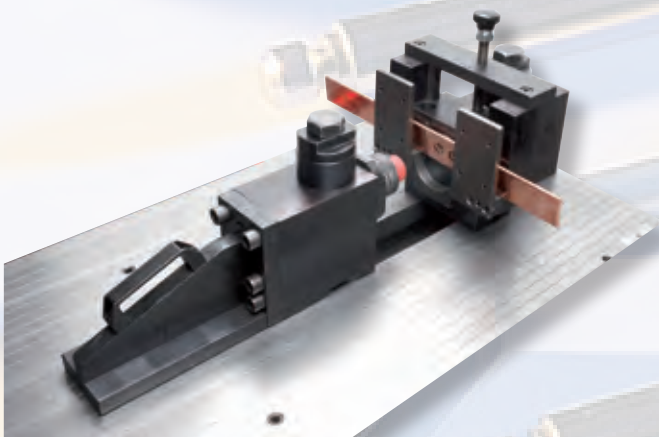

Punzonatura BUS BARS
BUS BARS punching

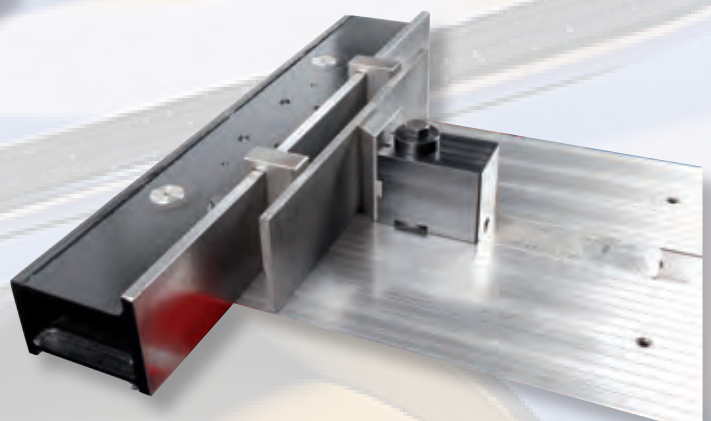

Raddrizzatura barre
Bars straightening

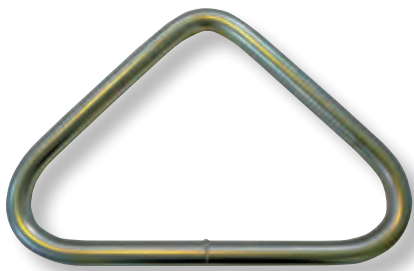

Tubo Ø 30
 Carpenteria pesante
 Pipe Ø 30
 Heavy steel structural work

1



Tubo Ø 25
 Carpenteria pesante
 Pipe Ø 25
 Heavy steel structural work

2



Barra sagomata
 Arredo e ornamentali / Inferriate / Balconi /
 Serramenti
 Shaped bar
 Art decor Furniture / Grating / Balconies /
 Framing

3



Tubo Ø 30
 Carpenteria pesante
 Pipe Ø 30
 Heavy steel structural work

4



Tubo Ø 25
 Carpenteria pesante
 Pipe Ø 25
 Heavy steel structural work

5



Barra sagomata
 Arredo e ornamentali / Inferriate / Balconi /
 Serramenti
 Shaped bar
 Art decor Furniture / Grating / Balconies /
 Framing

6



Tubo Ø 30
 Carpenteria pesante
 Pipe Ø 30
 Heavy steel structural work

7



Tubo Ø 25
 Carpenteria pesante
 Pipe Ø 25
 Heavy steel structural work

8



Barra sagomata
 Arredo e ornamentali / Inferriate / Balconi /
 Serramenti
 Shaped bar
 Art decor Furniture / Grating / Balconies /
 Framing

9

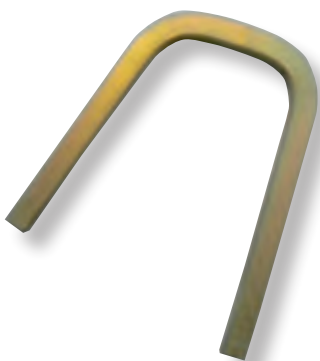

Barra sagomata quadro 20x20
arredamento per interni

Shaped bar square 20x20
interior decoration

10



Tondo sagomato
Carpenteria metallica

Shaped round bar
Steel structural work

11



Tondino sagomato Ø 16
edilizia

Shaped round bar Ø 16
building

12

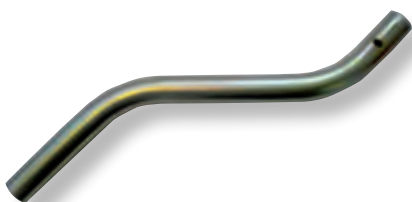

Tubo sagomato forato
arredamenti

Shaped and punched pipe
furnishing

13

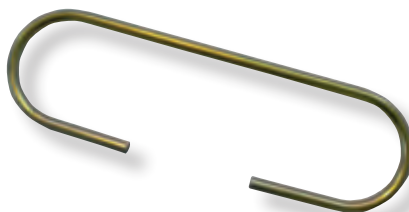

Tubo sagomato Ø 16
Arredo e ornamentali / Inferriate / Balconi /
Serramenti

Shaped pipe Ø 16
Art decor Furniture / Grating / Balconies /
Framing

14



Tubo rettangolare sagomato forato
carpenteria pesante

Rectangular shaped and punched pipe
heavy carpentry

15



Tubo sagomato forato
edilizia

Shaped and punched pipe
building

16



Tubo sagomato forato
edilizia

Shaped and punched pipe
building

17



Tubo sagomato forato
edilizia

Shaped and punched pipe
building

18



Cavallotti
Impiantistica civile/industriale

U gutter
Civil and industrial plant design

19

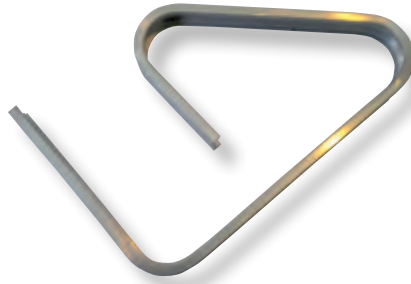

Barra sagomata
Carpenteria

Shaped bar
Steel structural work

20



Staffe sagomate e forate
Automotive/ impiantistica civile/industriale

Shaped and punched bracket
Automotive/ civil and industrial plant design

21



Barre quadrate e tonde curvate
Edilizia - carpenteria pesante

Square and round bars bent
Building - heavy steel structural work

22



Barra curvata
Arredamento

Bent bar
Furnishings

23



Barra di rame piegata e punzonata
Quadri elettrici

Copper bus-bar punched and bent
Electric cabinets

24

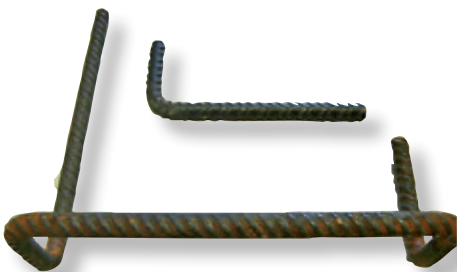

Tondino sagomato
Edilizia

Shaped corrugated round bar
Building

25



U-Bolts
Edilizia / Costruzioni / Macchine agricole /
Impiantistica industriale

U-Bolts
Building / agricultural machineries /
industrial plant design

26



Barra di rame piegata e punzonata
Quadri elettrici

Copper bus-bar punched and bent
Electric cabinets

27



Cerchi ed anelli
 Arredo e ornamentali / Inferriate / Balconi / Serramenti

Round shapes and rings
 Art decor Furniture / Grating / Balconies / Framing

28

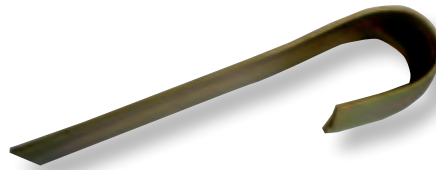

Barra sagomata a U
 Arredo e ornamentali / Inferriate / Balconi / Serramenti

U-shaped bar
 Art decor Furniture / Grating / Balconies / Framing

29



Anello e quadri sagomati
 Arredo e ornamentali / Inferriate / Balconi / Serramenti

Ring and shaped squares
 Art decor Furniture / Grating / Balconies / Framing

30



Barre sagomate
 Componenti per automotive

Shaped bars
 Automotive parts

31



Tubo rettangolare sagomato
 Cartellonistica stradale

Shaped rectangular pipe
 Road signs

32



Barre sagomate
 Componenti per scaffalature metalliche

Shaped bars
 Metal shelves parts

33



Ricci/cuori per decorazioni artistiche
 Arredo e ornamentali / Inferriate / Balconi / Serramenti

Curled shapes for artistic decorations
 Art decor Furniture / Grating / Balconies / Framing

34



Ricci/cuori per decorazioni artistiche
 Arredo e ornamentali / Inferriate / Balconi / Serramenti

Curled shapes for artistic decorations
 Art decor Furniture / Grating / Balconies / Framing

35

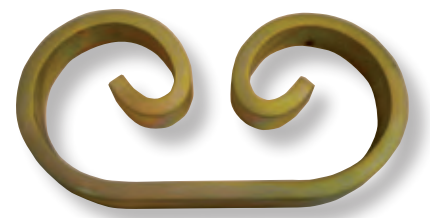

Ricci/cuori per decorazioni artistiche
 Arredo e ornamentali / Inferriate / Balconi / Serramenti

Curled shapes for artistic decorations
 Art decor Furniture / Grating / Balconies / Framing

36

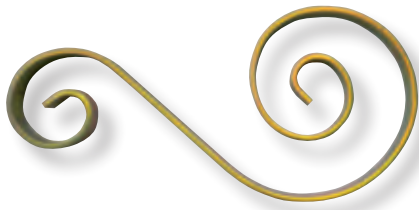

Ricci/cuori per decorazioni artistiche
 Arredo e ornamentali / Inferriate / Balconi /
 Serramenti

Curled shapes for artistic decorations
 Art decor Furniture / Grating / Balconies /
 Framing

37

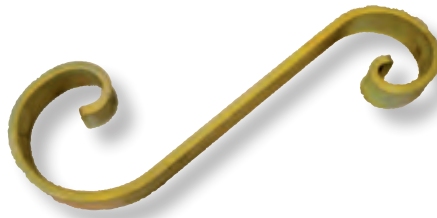

Ricci/cuori per decorazioni artistiche
 Arredo e ornamentali / Inferriate / Balconi /
 Serramenti

Curled shapes for artistic decorations
 Art decor Furniture / Grating / Balconies /
 Framing

38



U-Bolts
 Edilizia / Costruzioni / Macchine agricole /
 Impiantistica industriale

U-Bolts
 Building / agricultural machineries /
 industrial plant design

39



U-bolts piegati a caldo
 Edilizia / Costruzioni / Macchine agricole /
 Impiantistica industriale

Hot-bent U-Bolts
 Building / agricultural machineries /
 industrial plant design

40

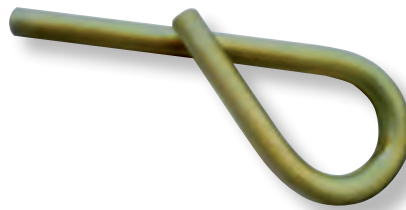

Tondino sagomato
 Edilizia / Costruzioni / Macchine agricole /
 Impiantistica industriale

Shaped round bar
 Building / agricultural machineries /
 industrial plant design

41



Tondino sagomato
 Edilizia / Costruzioni / Macchine agricole /
 Impiantistica industriale

Shaped round bar
 Building / agricultural machineries /
 industrial plant design

42

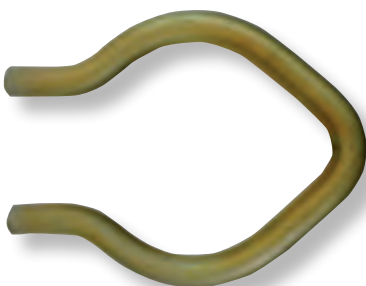

Tondino sagomato
 Edilizia / Costruzioni / Macchine agricole /
 Impiantistica industriale

Shaped round bar
 Building / agricultural machineries /
 Industrial plant design

43



Ganci
 Impiantistica industriale

Hooks
 Industrial plant design

44

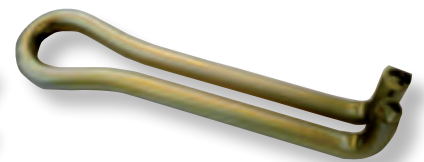

Ganci
 Impiantistica industriale

Hooks
 Industrial plant design

45

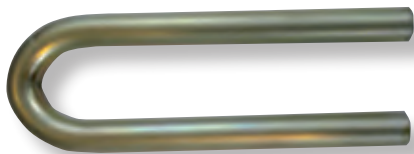

U-BOLTS
 Impiantistica industriale

U-BOLTS
 Industrial plant design

46



Chiavistello / tondino sagomato
 Impiantistica industriale

Latch / shaped round bar
 Industrial plant design

47



Chiavistello / tondino sagomato
 Impiantistica industriale

Latch / shaped round bar
 Industrial plant design

48



Chiavistello / tondino sagomato Ø 25
 Impiantistica industriale

Latch / shaped round bar Ø 25
 Industrial plant design

49



Barra sagomata
 Arredo e ornamentali / Inferriate / Balconi /
 Serramenti

Shaped bar
 Art decor Furniture / Grating / Balconies /
 Framing

50



Tubo sagomato
 Carpenteria metallica

Shaped pipe
 Steel structural work

51



Tondino sagomato Ø 22
 Carpenteria pesante

Shaped round bar Ø 22
 Heavy steel structural work

52

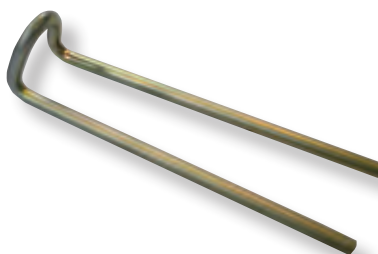

Tondino sagomato
 Carpenteria metallica

Shaped round bar
 Steel structural work

53



Cerniere
 Componenti per container

Hinges
 Container parts

54

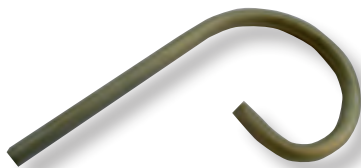

Tondino sagomato a spirale
 Arredo e ornamentali / Inferriate / Balconi / Serramenti

Spiral shaped round bar
 Art decor Furniture / Grating / Balconies / Framing

55



Cerniere
 Serramenti / Porte industriali / Balconi

Hinges
 Framing / Industrial doors / Balconies

56

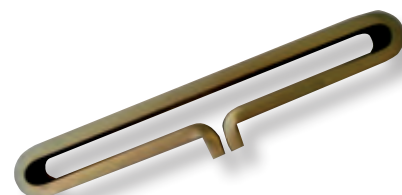

Piatto sagomato
 Edilizia stradale

Shaped flat bar
 Road plant design

57



Tubo graffato, punzonato e scantonato
 Edilizia

Seamed, punched and notched pipe
 Building

58



Tubo sagomato
 Carpenteria leggera

Shaped pipe
 Steel structural work

59

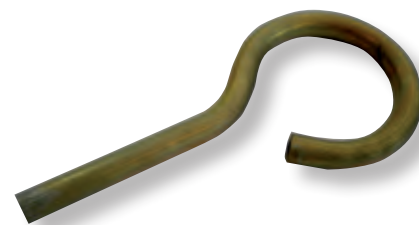

Tondo sagomato
 Carpenteria metallica

Shaped round bar
 Steel structural work

60

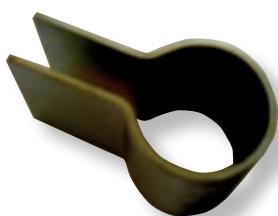

Piatto sagomato
 Impiantistica industriale

Shaped flat bar
 Industrial plant design

61

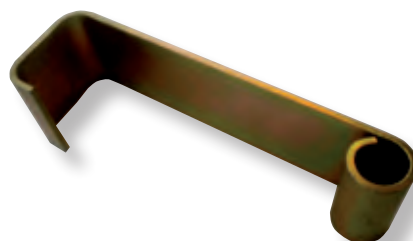

Cerniera
 Serramenti / Porte industriali / Balconi

Hinge
 Framing / Industrial doors / Balconies

62



Barra sagomata U
 Carpenteria pesante

U-shaped bar
 Heavy steel structural work

63

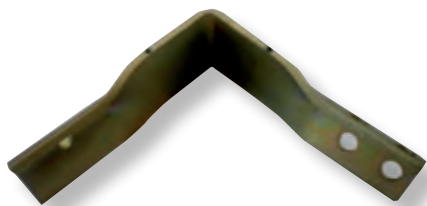

Staffa
Edilizia

Bracket
Building

64

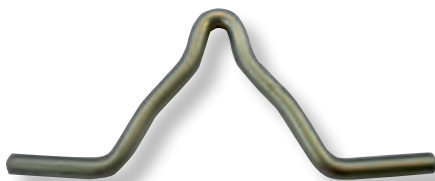

Tondino sagomato
Arredamenti

Shaped round bar
Furnishing

65

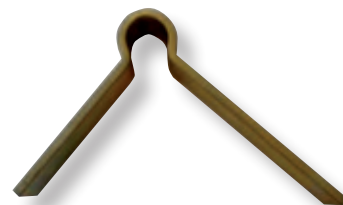

Piatto sagomato
Serramenti

Shaped flat bar
Framing

66



Staffa
Carpenteria pesante

Bracket
Heavy steel structural work

67

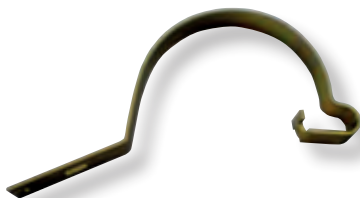

Cavallotto per grondaie
Edilizia / Impiantistica civile / Impiantistica
Industriale

U-gutter
Building / Civil plant design / Industrial plant
design

68

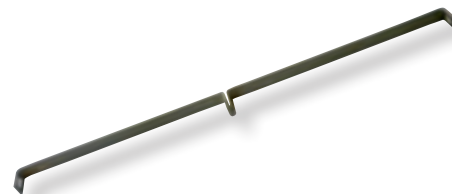

Piatto sagomato
Arredo e ornamentali / Inferriate / Balconi /
Serramenti

Shaped flat bar
Art decor Furniture / Grating / Balconies /
Framing

69



Tubo graffato, punzonato e scantonato
Edilizia / Impiantistica civile / Impiantistica
Industriale

Seamed, punched and notched pipe
Building / Civil plant design / Industrial plant
design

70

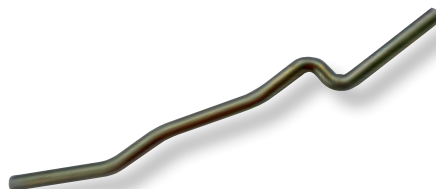

Tondino sagomato
Arredamenti

Shaped round bar
Furnishing

71

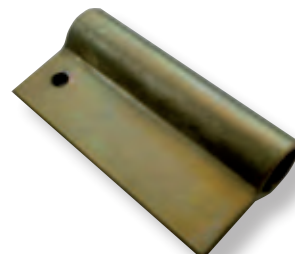

Cerniera
Serramenti

Hinge
Framing

72

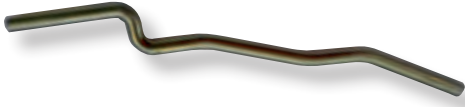

Tondino sagomato
Arredamenti

Shaped round bar
Furnishing

73

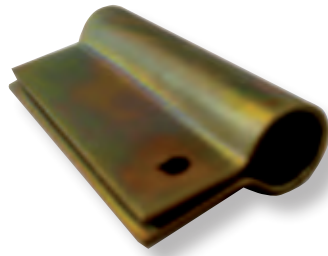

Cerniera
Serramenti

Hinge
Framing

74



Barra di rame piegata e punzonata
Quadri elettrici

Copper bus-bar punched and bent
Electric cabinets

75



Cavallotto punzonato
Edilizia / impiantistica industriale

Punched U gutter
Buildings / industrial plant design

76



Particolare meccanico
Industria meccanica

Special mechanical part
Mechanical industry

77

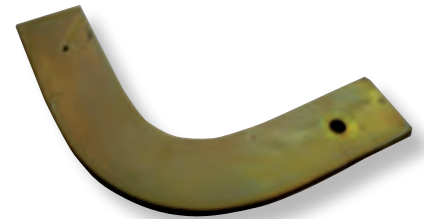

Barra sagomata in costa
Impiantistica industriale

Flat bar with bending on edge
Industrial plant design

78



Tondino sagomato
Impiantistica industriale / elettrica

Shaped round bar
Industrial and electrical plant design

79

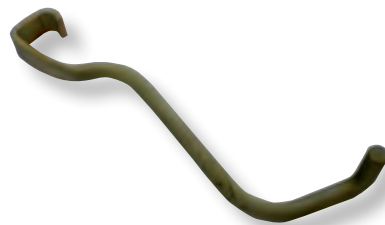

Tondino sagomato
Edilizia / Costruzioni / Impiantistica elettrica
/ recinzioni

Shaped round bar
Building / Electric plant design / Fencing

80



Staffa
Impiantistica industriale

Bracket
Industrial plant design

81

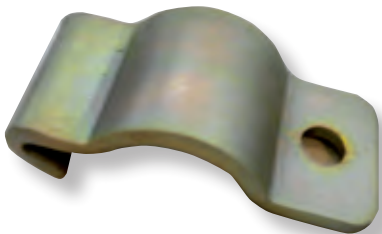

Cavallotto
Edilizia / Costruzioni / Impiantistica civile e industriale

U-gutter
Building / Industrial and civil plant design /

82

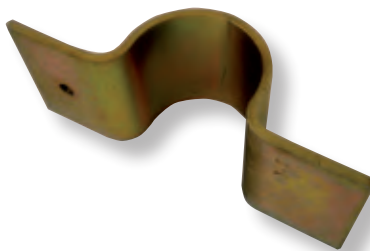

Cavallotto R.I. 30
Edilizia / Costruzioni / Impiantistica civile e industriale

U gutter I. R. 30
Building / Industrial and civil plant design /

83

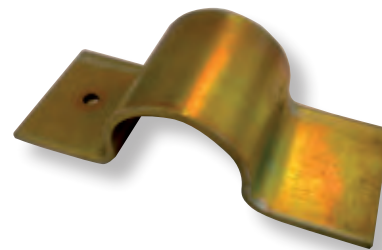

Cavallotto R.I. 26
Edilizia / Costruzioni / Impiantistica civile e industriale

U gutter I. R. 26
Building / Industrial and civil plant design /

84

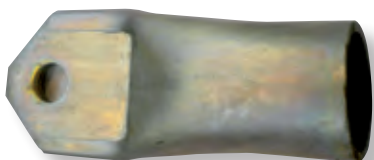

Tubo graffato, punzonato e scantonato
Edilizia

Seamed, punched and notched pipe
Building

85



Cavallotti
Edilizia / Costruzioni / Impiantistica civile e Industriale

U-gutters
Building / Industrial and civil plant design /

86



Gancio piatto
Impiantistica elettrica

Flat hook
Electric plant design

87

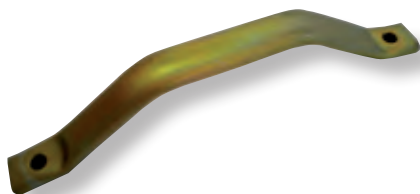

Maniglione piegato e punzonato
Arredamenti industriali

Bent and punched handle
Industrial furnishings

88

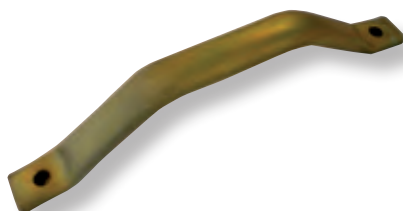

Maniglione piegato e punzonato
Arredamenti industriali

Bent and punched handle
Industrial furnishings

89



Staffa
Edilizia

Bracket
Building

90



Staffa
Edilizia

Bracket
Building

91

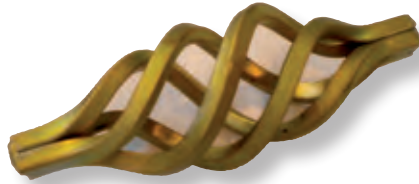

Decorazioni artistiche
Arredo e ornamentali / Inferriate / Balconi / Serramenti

Artistic decorations
Art decor Furniture / Grating / Balconies / Framing

92

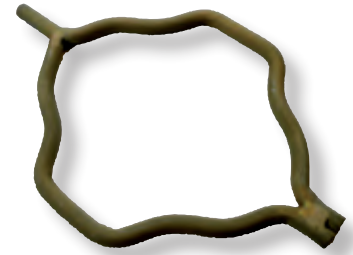

Griglie per saracinesche
Saracinesche

Grills for gates
Gates

93

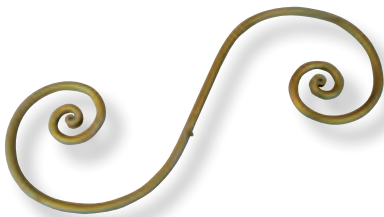

Ricci per decorazioni artistiche
Arredo e ornamentali / Inferriate / Balconi / Serramenti

Curled shapes for artistic decorations
Art decor Furniture / Grating / Balconies / Framing

94



Ricci per decorazioni artistiche
Arredo e ornamentali / Inferriate / Balconi / Serramenti

Curled shapes for artistic decorations
Art decor Furniture / Grating / Balconies / Framing

95

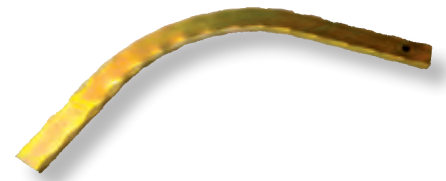

Particolari per inferriate artistiche
Arredo e ornamentali / Inferriate / Balconi / Serramenti

Parts for artistic gates
Art decor Furniture / Grating / Balconies / Framing

96



Barra tonda curvata
Carpenteria pesante

Bent round bar
Heavy steel structural work

97



Decorazioni artistiche
Arredo e ornamentali/inferriate/ balconi e serramenti

Artistic decorations
Art decor Furniture / Grating / Balconies / Framing

98



Barra curvata in costa
Impiantistica industriale

Bar bent on edge
Industrial plant design

99

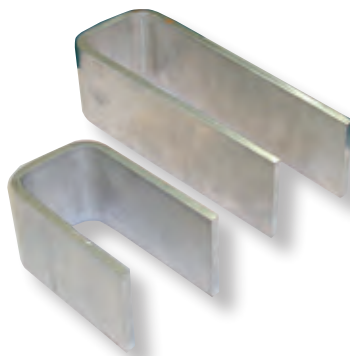

Barre di alluminio piegate
Impianti elettrici

Aluminum bars
Electric plants

100

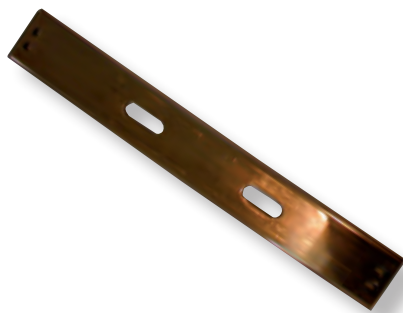

Barra di rame piegata e punzonata
Quadri elettrici

Copper bus-bar punched and bent
Electric cabinets

101



Barra di rame piegata in costa

Copper bar bent on the edge

102



Barra di rame piegata in costa
Impianti elettrici

Copper bar bent on the edge
Electric plants

103



Barra di rame piegata in costa

Copper bar bent on the edge

104



Barra di rame piegata
Impianti elettrici

Copper bent bar
Electric plants

105



Tubo Ø 30
Carpenteria pesante

Pipe Ø 30
Heavy steel structural work

106



Tondino sagomato
Edilizia / Costruzioni / Macchine agricole /
Impiantistica industriale

Shaped round bar
Building / agricultural machineries /
Industrial plant design

107



Tondo sagomato
Carpenteria metallica

Shaped round bar
Steel structural work

108

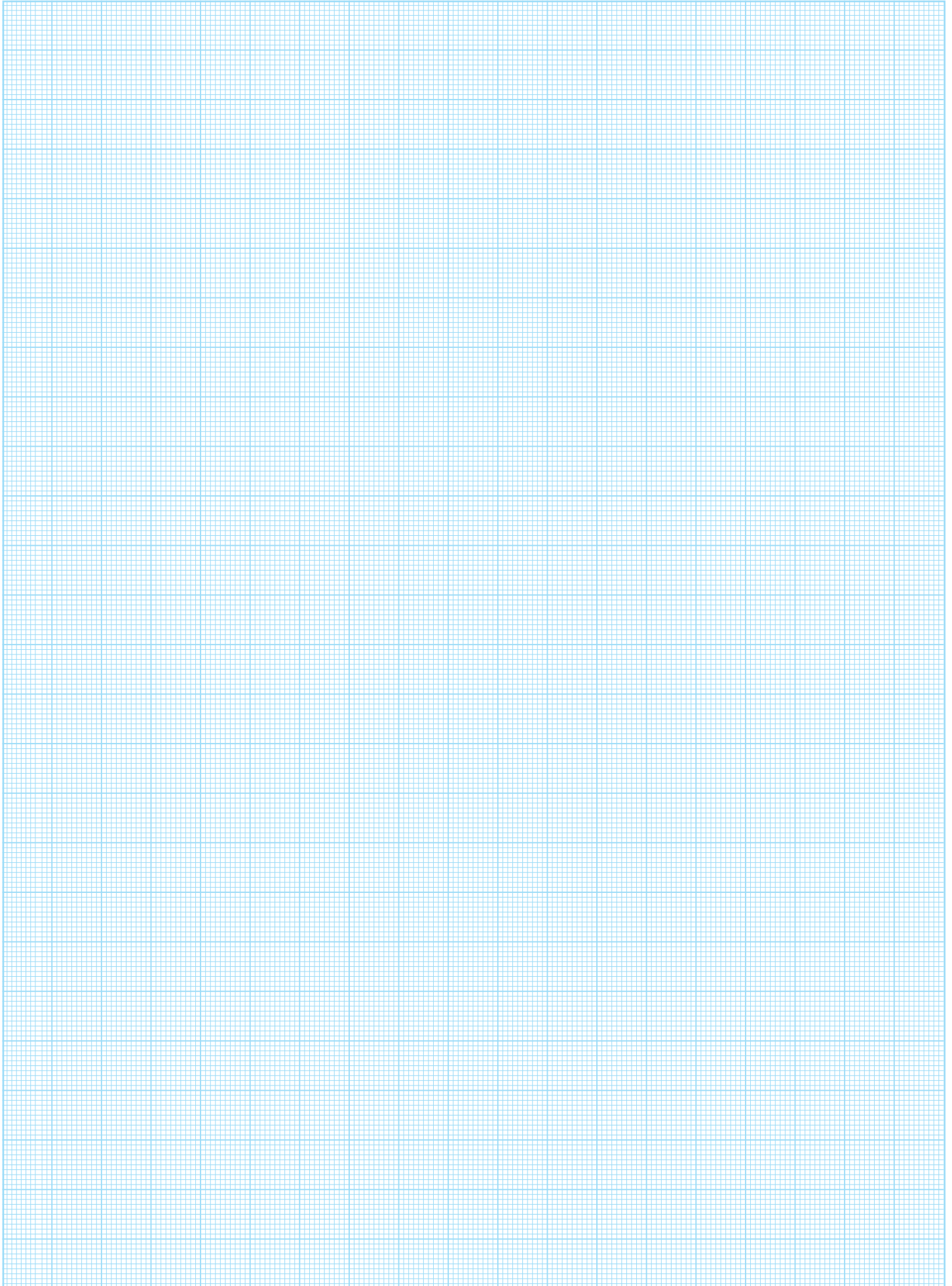



Made in Italy since 1957

We manufacture machines for



Представитель в России:
ООО «ПО ИП»
Тел: +7 (812)602-77-08
E-mail: info@poip.ru
www.poip.ru

S.I.M.A.S.V. S.r.l. 36016 Thiene (Vicenza) Italy | Via dell'Industria, 3 - Z.I.
Tel. +39 0445 361256 | Fax +39 0445 364450

web site: www.simasv.it



e-mail: marketing@simasv.it