

- WHEN SKATE SHARPENING MATTERS -

# SSM PRODUKT AB

OFFICIAL CATALOG 2020



Представитель в России:

ООО «ПО ИП»

Тел: +7 (812)602-77-08

E-mail: [info@poip.ru](mailto:info@poip.ru)

[www.poip.ru](http://www.poip.ru)

SSM  
SKATE SHARPENING MACHINES

SSM Produkt AB has been a manufacturer of skate sharpening machines and skate riveting machines since 1979. The first model was created already back in 1968 by the founders of the company (then within another company).

The company has always been located in Uppsala, Sweden.

Our high quality products come with a 2-year warranty. We always focus on quality, precision and ease of operation when we design our products. The machines are made to last for many years. Every now and then we get machines back for service that are still working after 40 years in use. Our product range has grown over the years; we now provide a complete solution for maintaining skates.

Every year something new happens in the skate sharpening area that we have to adjust to, whether it is a new skate model that arrives which is difficult to sharpen or a new technique which we have to consider. We always strive to make our machines the best ones available. So year after year we make minor modifications to our current product line to achieve near perfection.

A good thing to know is that we also make our new products and modifications compatible with older versions of our products. So if you need/want to replace a part on your machine, you can always install the latest version of that part. We also continue to update our product range with new products that are sought after. This is to maintain our position as one of the biggest brands worldwide in the market of skate sharpening machines.



**Web:**

#### OUR FACTORY IN SWEDEN



*Our machines are currently being used world-wide by several national teams, a large number of professional and amateur teams as well as stores, ice rinks and portable ice rinks.*

*Outside Sweden, SSM is normally represented by agents and resellers.*

*Over the last ten years our machines have been sold to the countries and regions marked in red.*



The second generation of the skate sharpening station SSM TT-3 has been released. Its predecessor was SSM-T26, an addition to the SSM-2 for sharpening figure skates. Thanks to the new design of the machine it will now manage almost every skate on the market. This machine has become very popular. People who are using it like how easy it feels to sharpen a skate. They also enjoy the smooth finish on the skating surface underneath the skate blade.

## EASY SETTING

This machine has an efficient system for centering the sharpening underneath the skate blade very accurately. We got the idea when we designed the SRK PRO for SSM-2.

You just have to measure the skate blade width and turn a scale to that measurement to get centering.

This device has an incredible precision!

## FAST

Just like the SSM-2 this machine will sharpen a skate in under a minute!

## FEELS AMAZING

The design with two tables moving on top of shafts (using bearings) gives a simply amazing feeling. No friction to talk about whatsoever!

## SHARPEN ANY SKATE

The new skate holder will manage almost every skate on the market today.

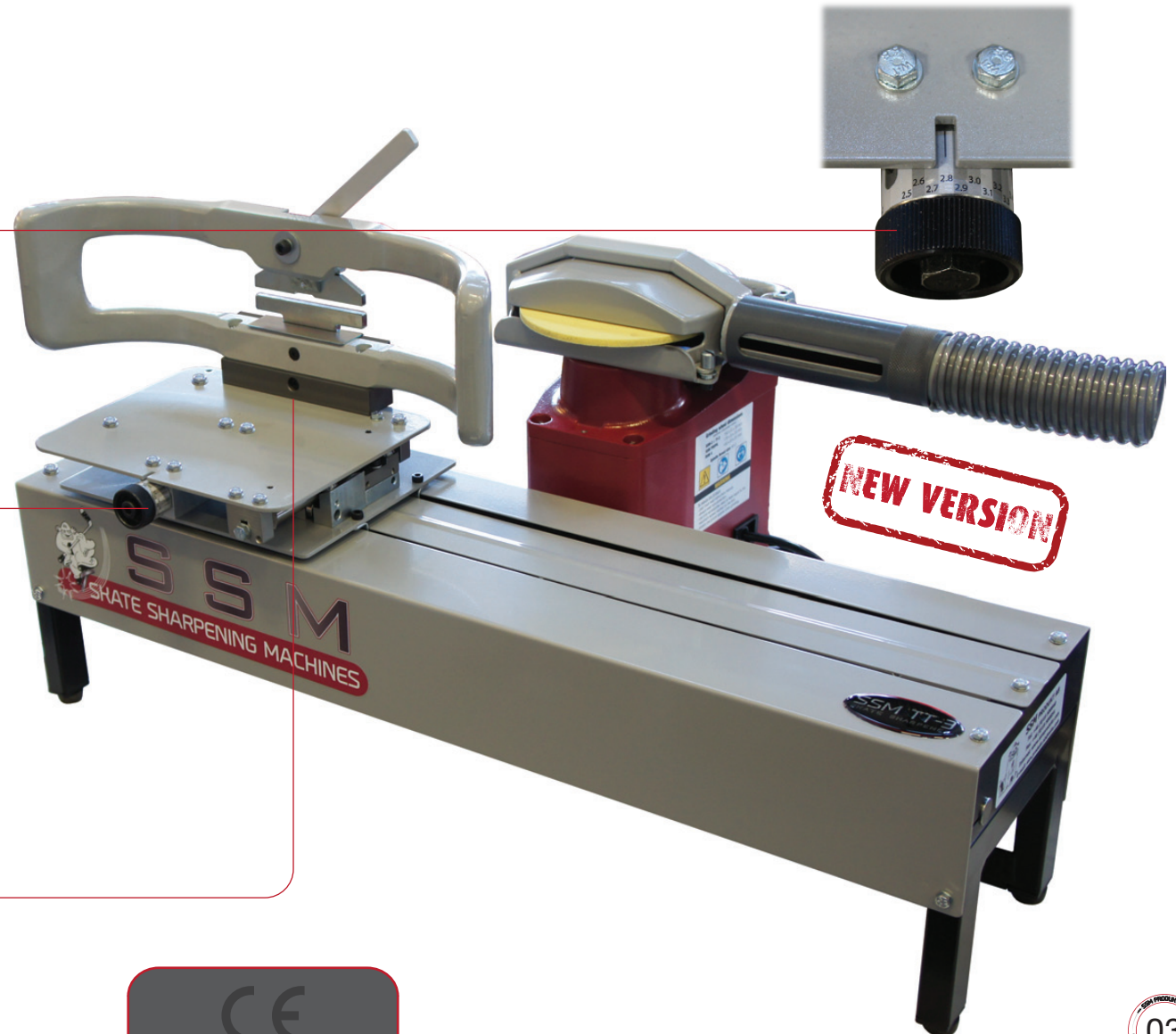

SSM-2 is one of the most popular skate sharpening machines in the world. The sales record speaks for itself, an astonishing 20000 pcs. sold so far throughout the world. This portable high quality skate sharpener is intended to do the finishing sharpening (flat or hollow) on skates. The main advantage with SSM-2 is that it is very fast and easy to use while delivering great precision. The SSM-2 is available in a CE-approved 220-240 V version and an ETL-approved 110-120 V version.

## EASY SETTING

By using a guide arm holding the skate blade, and a blade support roller just in front of the grinding wheel, the SSM-2 models will position a hollow very precisely using only one height adjustment point. *This is so even if the blade is not completely straight (which it almost never is). No other design can match this.*

Furthermore there is no possibility that the hollow will be formed diagonally along the blade.

## FAST

The design of the guide arm makes moving the skate very easy.  
*Sharpen a skate in under a minute!*

## PORTABLE AND DURABLE

SSM-2 has a strong and compact design but is still relatively light weight; this makes it *ideal for transportation*. For such use we have transport cases available.

## SPECIFICATIONS

Length: 35 cm  
Width: 25 cm  
Height: 32 cm  
Weight: 14.8 kg (31 lbs).



## SSM-2 VERSUS SSM-2 PRO

These machines use different models of the blade support device.

The SSM-2 uses an adjustment screw to adjust the height of blade support roller.



The SSM-2 PRO uses an exact scale which you can easily turn to correspond to the skate blade thickness.

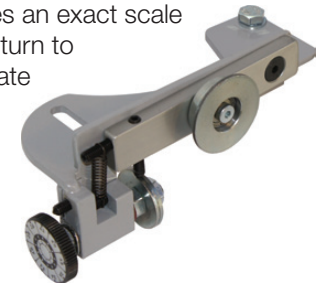

Both devices have an incredible precision but the SRK PRO is much more convenient to use.

## SHARPEN ANY SKATE

There are several skate holders to choose from, to make it possible to sharpen any kind of skate. Check the next page...

## SKATE HOLDERS FOR SSM-2 AND SSM-2 PRO

### Choose a holder that suits you

There are a number of different skate holders to add to your SSM-2 or SSM-2 PRO.

Our universal holders will be able to grip most skates, but some skate models are designed in a way that requires you to use special skate holders.

#### H-10 universal

- Latest version of our universal skate holder.
- The most common choice among users.
- Strong grip.
- Flexible with low weight.

**MOST POPULAR**

Will essentially manage all skates on the market today except:

- Skate blades that are not parallel (certain figure skates).
- Skate blades with thick skate blade chassis (certain figure skates).
- Really large goalie skates.



#### H-5 original

- The classic holder.
- Popular among teams who travels.
- Very strong grip.
- Small with very low weight.

Will essentially manage all skates on the market today except:

- Skate blades that are not parallel (certain figure skates).
- Skate blades with thick skate blade chassis (certain figure skates).
- Goalie skates.
- Small children's skates.
- Touring skates.



# SKATE HOLDERS FOR SSM-2 AND SSM-2 PRO

## If you only intend to sharpen for figure skating

Our universal holders will be able to grip most of the figure skates. Some of the more exclusive figure skate blades requires that you use a special holder.

### H-10S figure

- Special holder made for figure skates.
- Designed to grip on the stanchions.
- One extra jaw included (to manage thick skate blade chassis).
- Only holder we have that manages Paramount SK8S.

Will essentially manage all figure skates on the market today except:

- Skate blades that are not parallel (certain figure skates).

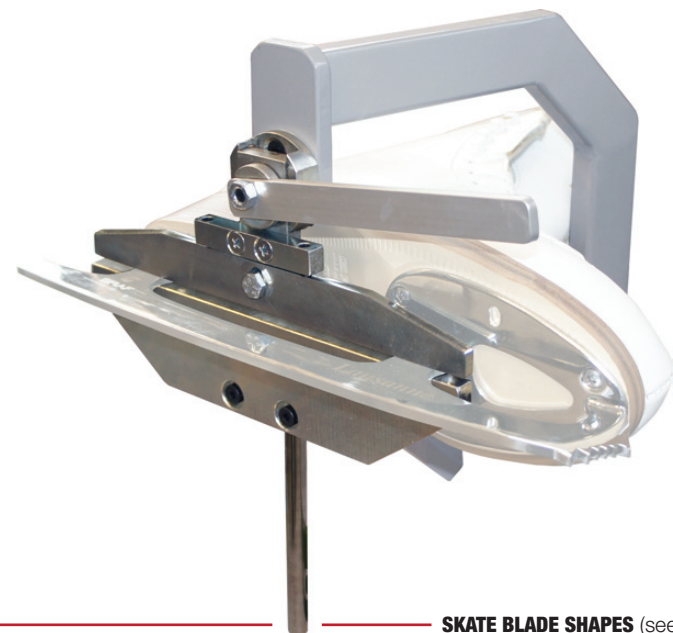

**SKATE BLADE SHAPES** (seen from underneath)



**Regular** - Parallel shape.



**Tapered** - Front is thicker and rear is narrower.  
Is intended to reduce friction on the ice and provide more control.

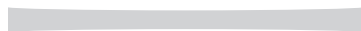

**Parabolic** - Blade is thinner in the middle. This centres your weight and increases stability and precision.  
Is intended to create less drag as you move across the ice.



### H-10P figure

- Special holder made for figure skates.
- Designed to manage figure skate blades having non-parallel shape:  
*Parabolic, Tapered, Side-honed and Tapered edge.*  
(Now also with those using Revolution stanchions.)

Will essentially manage all figure skates on the market today except:

- Paramount SK8S

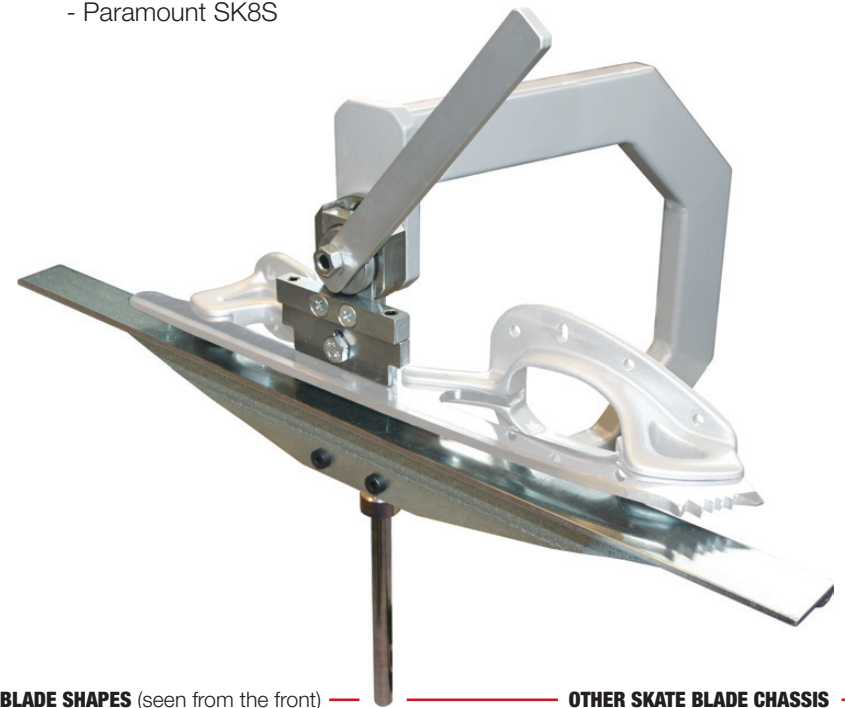

**OTHER SKATE BLADE SHAPES** (seen from the front)



**Regular**  
Parallel shape



**Slim line**  
Quicker edge-to-edge transfer



**Side-Honed**  
Increases the bite-angle  
Decreases weight



**Tapered Edge**  
Increases the bite-angle



**Aluminum or carbon fibre**  
Decreases the weight a lot

**OTHER SKATE BLADE CHASSIS**

SSM PROFIL is a skate sharpening machine specialized in making blade profiles. The big difference compared to other machines is that it is using the grinding wheel in a vertical position. By doing so you will get a lot of benefits when contouring. But what is most important is that it will let you profile skates much faster and more accurately. This machine uses contour templates when making shapes; four templates are included with the SSM PROFIL. You will need a SSM-2 or a SSM TT-3 afterwards to do the finishing sharpening (flat or hollow) on the skates. SSM PROFIL is available in a CE-approved 220-240 V version and an ETL-approved 110-120 V version. From 2016 it is also possible to fully copy a skate blade shape directly onto another skate blade by using the old skate blade as a template! (If an optimal shape has been found.)

## EFFECTIVE AND COOL GRINDING

By using a vertical grinding wheel you will get a very small contact surface between the skate blade and the grinding wheel.

This leads to faster removal of material and gives a cooler grind. You will be able to profile a skate in 1-5 minutes.

## SUPER ACCURACY

The vertical grinding wheel will guarantee an exact transfer of the contour from the template compared to using a horizontal grinding wheel.

Not having full work-pressure leads to bumps and undesirable shape on the skate blade.

## ELIMINATE ERRORS

This machine has a fine adjusting device that will help you align the skate blade perfectly after the template.

## NEW PITCH/PIVOT SYSTEM

In 2016 we designed an easy system to shift the contour template to alter the pivot/pitch of profiles very accurately.

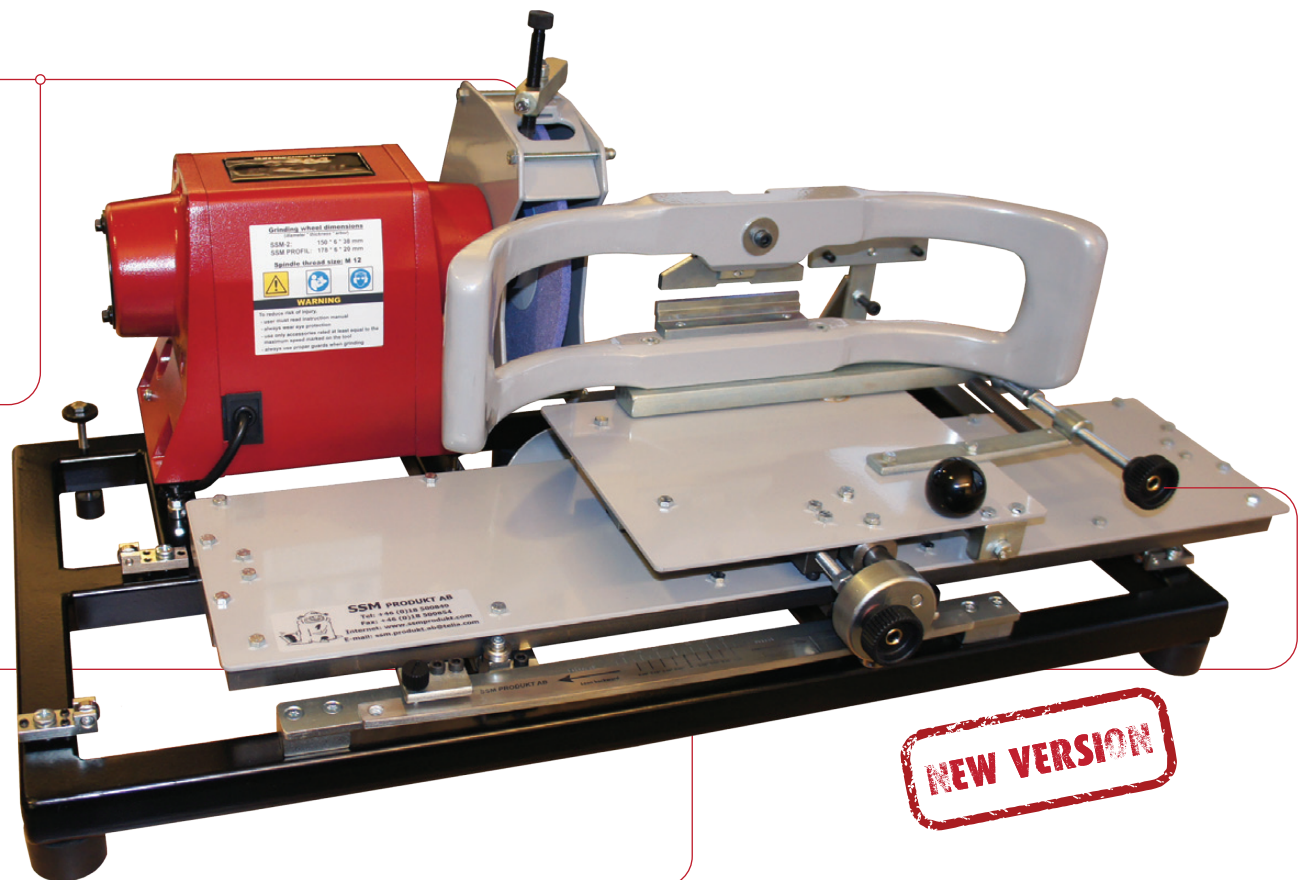

# SHARPENING ACCESSORIES - GRINDING WHEELS

## Get the best sharpening result

Skate steel varies in quality and type. Therefore it is important to use a suitable grinding wheel. Our products have been thoroughly tested to keep up with today's standards. The grinding wheels are made within a specific balance and its sides are finished.

With average usage, a grinding wheel is sufficient for 200-300 pairs of skates.



### S-2/HP70 "high performance"

- For all steels.
- *Mounted on every new machine!*
- Very successful grit mixture.
- Quite aggressive cut.
- Excellent surface finish.
- Optimal profile retention.
- Increased wheel life.
- *Popular among teams & clubs!*



### S-2/ME60 "most efficient"

- For all steels.
- *\*Ceramic grit!*
- Aggressive cut.
- Great surface finish.
- General purpose wheel.
- *Popular among stores & ice rinks!*



### S-2/K80 "super finish"

- For all steels.
- *\*Ceramic grit!*
- Masterly surface finish.
- *Popular among teams & clubs!*



### S-2/60 "old standard"

- *Only for carbon steel!*
- Cheapest model.
- Aggressive cut.
- Nice surface finish.

## speed of abrasion

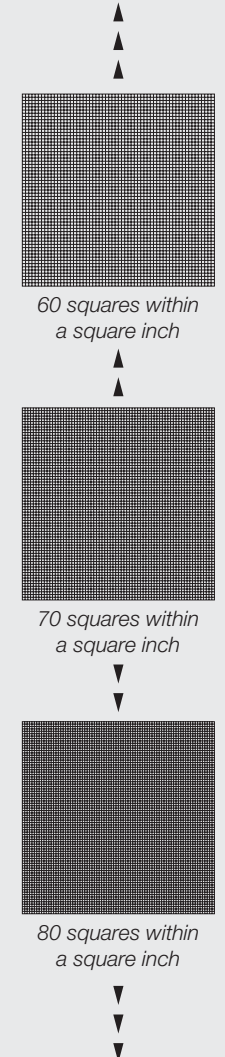

## surface finish

### \*Ceramic grit, self-sharpening process:

During use, new edges are created within the grit, increasing its performance compared to conventional sharpening grit. Ceramic grit particles keep their sharpness better, last longer and cause less heat to be generated, but cost more.

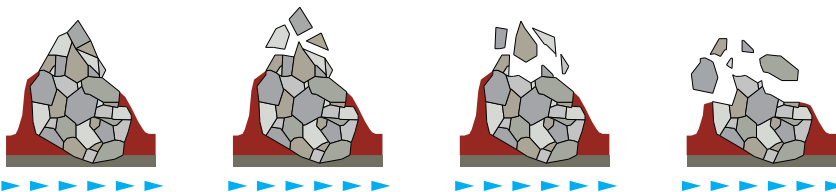

## SHARPENING ACCESSORIES - DIAMOND DRESSERS

### Keep the grinding wheel sharp and correct

As you sharpen, the grinding wheel needs to be dressed every now and then to make new grit available or to reshape it. A poor finish underneath the skate blade or blade chatter (even though you have dressed the grinding wheel) is probably a sign that the diamond is dull and needs to be replaced.

*With average usage, a diamond dresser is sufficient for 4 grinding wheels.*



#### D-80

- Diamond dresser
- Natural diamond
- High quality



#### SD-80

- Diamond dresser
- Synthetic diamond rod
- Constantly the same sharpness



#### SD-50

- Diamond dresser
- Synthetic diamond rod
- Constantly the same sharpness
- Fits only in the flat surface device.

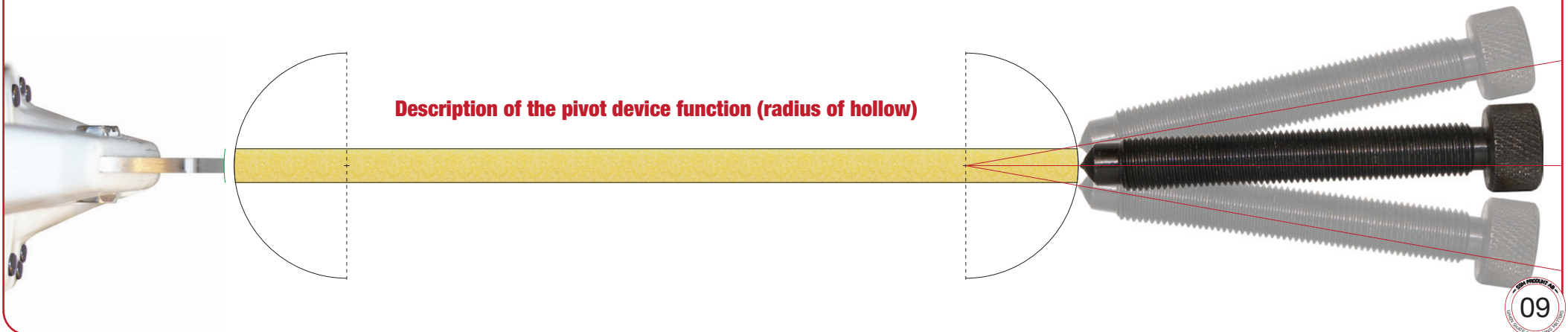

## SHARPENING ACCESSORIES - HAND HONES

### After sharpening

When a skate blade is sharpened to obtain sharp edges underneath, fine burrs will arise on the sides of the blade. Those burrs make the skate feel dull against the ice and increase friction. Use a hone (whetstone) to remove the burrs by pulling it evenly along the sides. Then you will have obtained perfect sharpness!

The hand hones can also be used to remove nicks before sharpening (if the skate blade is damaged).

*"Two hand hones can be rubbed against each other to keep them flat and clean. Even better is to rub a hand hone against an old grinding wheel."*



#### **B-SSM** hand hone

- Fine grit
- Silicon carbide
- 75x18x10 mm



#### **CB-SSM** hand hone

- Combination grit
- Fine / Coarse
- Aluminum oxide
- 75x18x10 mm



#### **BB-SSM** hand hone

- Fine grit
- Silicon carbide
- Wider version of B-SSM
- 75x25x10 mm



#### **DB-SSM** diamond hone

- Extreme sharpness
- Diamond layer keeps the shape
- Lasts a long time
- Precision tool - handle with care!
- 75x25x5 mm

Correct honing ✓



The hone is not flat ✗

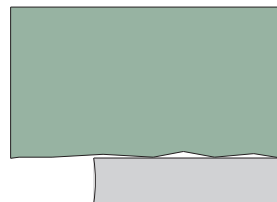

The hone is at an angle ✗

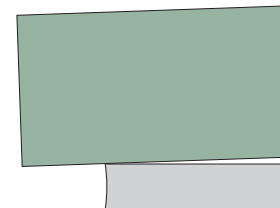

Follow the blade shape ✓

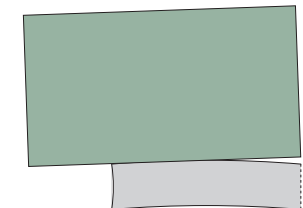

## SHARPENING EQUIPMENT - BLADE EDGE CHECKER

### Check the sharpening

Our Blade Edge Checker (BEC) is a tool for checking the sharpening.

It is a fast and accurate system to control whether a sharpening is centered underneath the skate blade (which is very important).

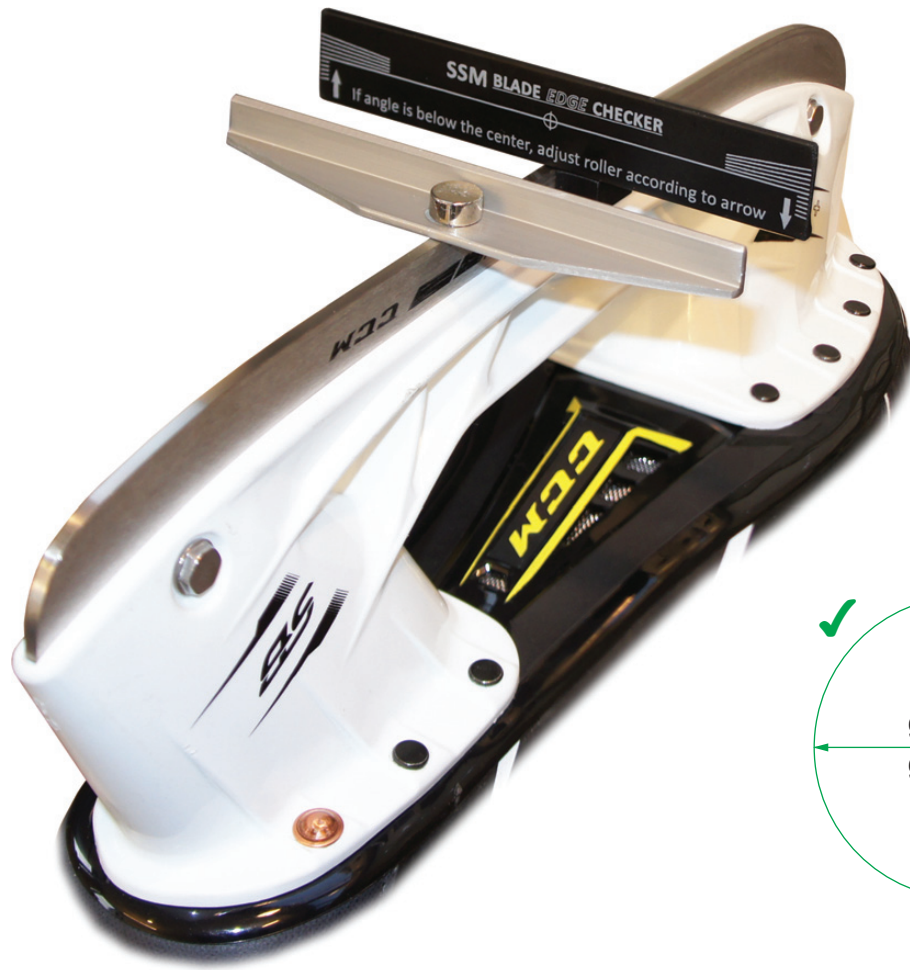

### BEC

- Tool for skate blades.
- Check the sharpening.
- Helps to center the sharpening.
- Attaches with strong magnets.
- Made in hardened aluminum

**BEST SELLER**

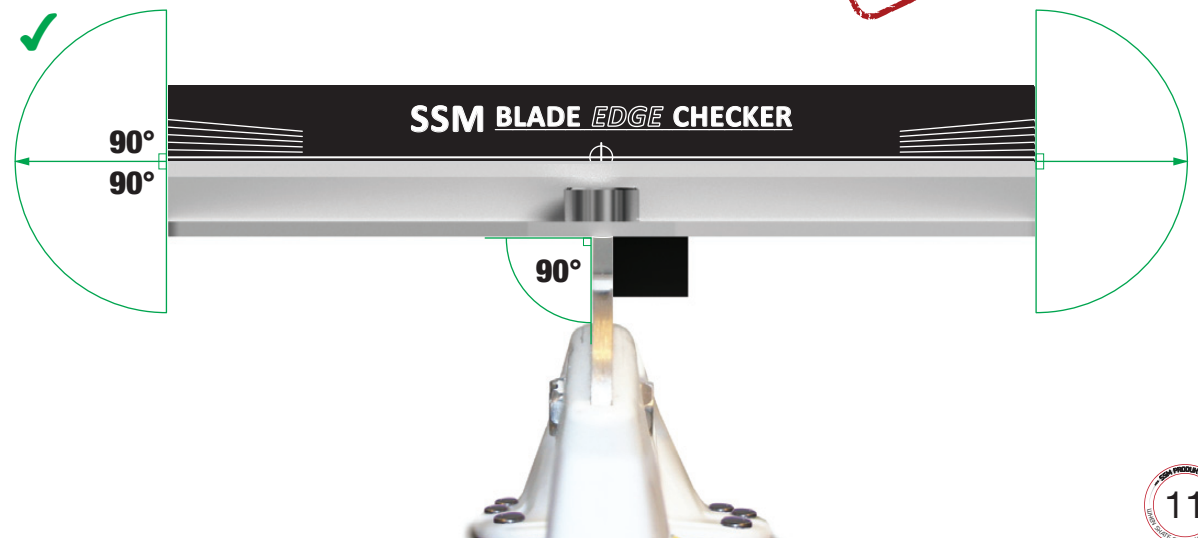

## SHARPENING EQUIPMENT - SKATE BLADE CONTROLLER

### Check the skate blade

With our measuring stick SBC (Skate Blade Controller) you can easily see the width of the skate blade. This is very practical when setting up the skate sharpening machine. You can also see which radius of hollow that has been sharpened on the skate blade. We have the full range from 8 mm up to 25 mm.



### SBC

- Tool for skate blades.
- Check the radius of hollow.
- Measure the skate blade width.
- Made in brushed stainless steel.

## SHARPENING EQUIPMENT - SRK PRO

### Adjustment for sharpening

This blade support device is included when you buy a SSM-2 PRO skate sharpening machine. It is also possible to buy it and attach it to older versions of SSM-2. SRK PRO is a fast and accurate system to calibrate (center) the skate blade against the grinding wheel. You only need to measure the width of the skate blade and turn the scale wheel to the obtained measure.

*"Using a blade support device will give you higher precision than other systems because it will also center the sharpening on skate blades which are not perfectly straight."*

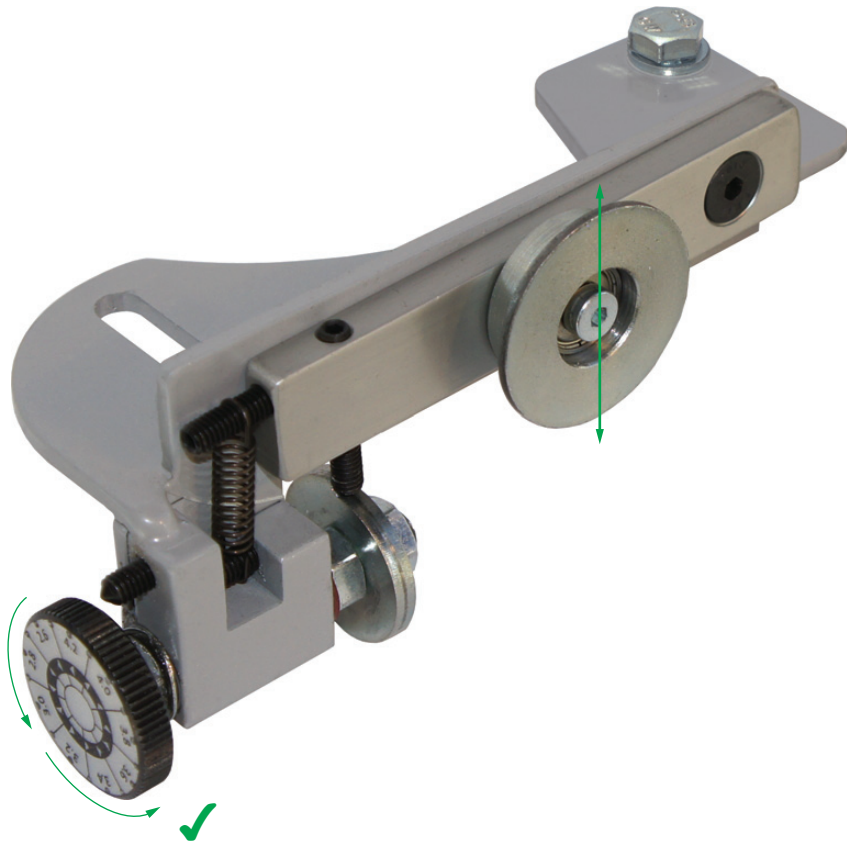

### SRK PRO

- Blade support device PRO.
- Scale for skate blade width.
- Scale range: 2.5 - 4.2 mm.
- Extreme precision.
- Perfectly centered sharpening.

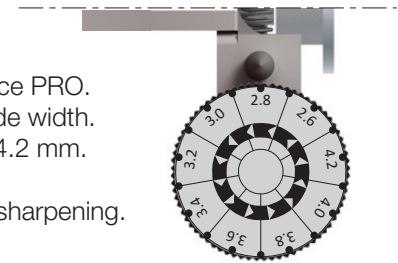

### Description of the blade support device

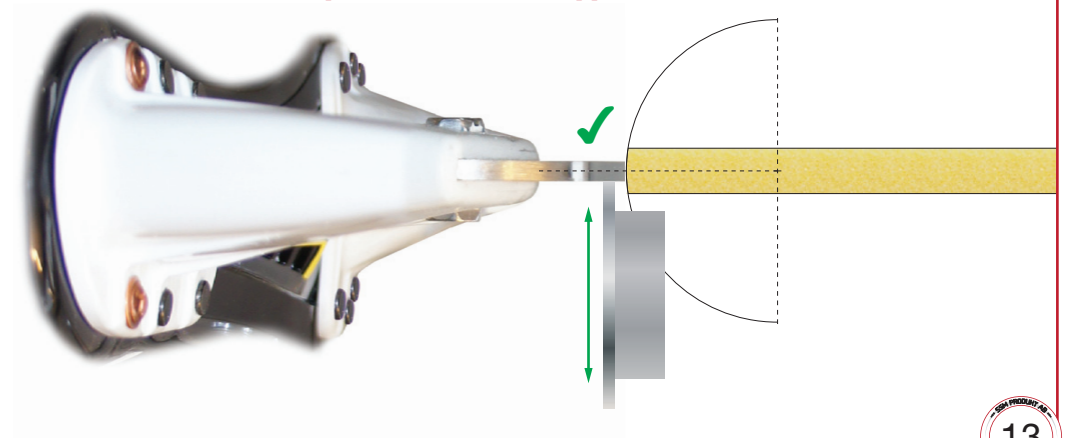

## SHARPENING EQUIPMENT

### ACCU

- Sharpening wax from Accu-Lube.
- Apply on skate blade.
- Use before the final "finish" pass.
- Increases surface finish.
- Gives a cooler sharpening process.



### TB2

- Transport case for SSM-2
- Durable to thrusts
- Tool holder on the inside
- Dimensions: 430x340x350 mm
- Weight: 6.1 kg

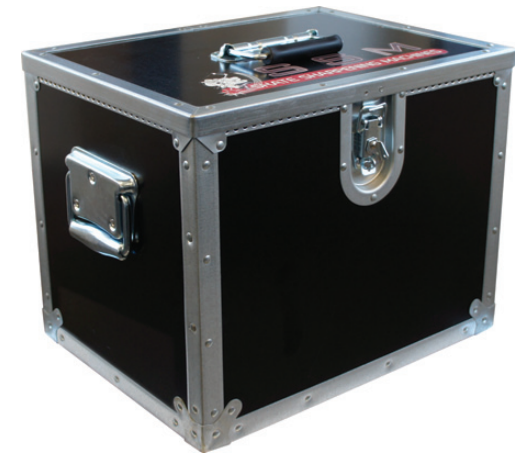

### SKR

- Blade straightener
- Easy to straighten skate blades



### TB3

- Transport case for SSM-2
- Durable to thrusts
- With wheels and pull-out handle
- Dimensions: 513x430x450 mm
- Weight: 12 kg



# PROFILING TEMPLATES

To improve your skating abilities it is important to find a shape/profile that suits your skating style. We have made a more comprehensive “sharpening guide” that covers this area more carefully. If you are interested please contact us for more information. Here below you can see all templates we have. We can also create templates if you have a specific request.

## CONTOUR TEMPLATES “single radius”

- Radius 7' (2.13 m)
  - Radius 8' (2.44 m)
  - Radius 9' (2.74 m)
  - Radius 10' (3.05 m)
  - Radius 11' (3.35 m)
  - Radius 12' (3.66 m)
  - Radius 13' (3.96 m)
  - Radius 14' (4.27 m)
  - Radius 15' (4.57 m)
  - Radius 16.4' (5 m)
  - Radius 19.7' (6 m)
  - Radius 23' (7 m)
  - Radius 26' (8 m)
  - Radius 28' (8.53 m)
  - Radius 30' (9.14 m)
  - Radius 32.8' (10 m)
- } Figure skating
- } Ice hockey
- } Bandy
- } Goalies

## CONTOUR TEMPLATES “split”

- NA Split 1 (radii 8.5' / 9.5')
- NA Split 2 (radii 9' / 10')
- NA Split 3 (radii 9.5' / 10.5')
- NA Split 4 (radii 10' / 11')
- SE Split 1 (radii 10' / 13')
- SE Split 2 (radii 10' / 16.4')
- Detroit 1 (radii 10' / 20')
- Detroit 2 (radii 13' / 26')
- Goalie Split (radii 24' / 28')

## CONTOUR TEMPLATES “several radii”

### Natural Curve “Quick”

- Radii A, 10', C, D (for sizes 246-254)
- Radii A, 10', C, D (for sizes 263-272)
- Radii A, 10', C, D (for sizes 280-288)
- Radii A, 10', C, D (for sizes 296-306)

### Natural Curve “Intermediate”

- Radii A, 13', C, D (for sizes 263-272)
- Radii A, 13', C, D (for sizes 280-288)
- Radii A, 13', C, D (for sizes 296-306)

### Natural Curve “Power”

- Radii A, 16', C, D (for sizes 263-272)
- Radii A, 16', C, D (for sizes 280-288)
- Radii A, 16', C, D (for sizes 296-306)

### Quad Intensify “Zero”

- Radii 6', 9', 11', 13' (for sizes 272-288)

## CONTOUR TEMPLATES “bandy”

- Bandy Youth R4/16 (radii 2m, 4m, 2m)
- Bandy Youth R5/16 (radii 2m, 5m, 2m)
- Bandy Youth R4/18 (radii 2m, 4m, 2m)
- Bandy Youth R5/18 (radii 2m, 5m, 2m)
- Bandy Elite R4/20 (radii 2m, 4m, 2m)
- Bandy Elite R5/20 (radii 2m, 5m, 2m)
- Bandy Elite R4/22 (radii 2m, 4m, 2m)
- Bandy Elite R5/22 (radii 2m, 5m, 2m)
- Bandy Elite Viklund (radii 1m, 5m, 1m)
- Bandy EX1 (radii 0.75, 3m, 4m, 5m, 6m, 0.75m)
- Bandy EX2 (radii 0.75, 4m, 5m, 6m, 7m, 0.75m)

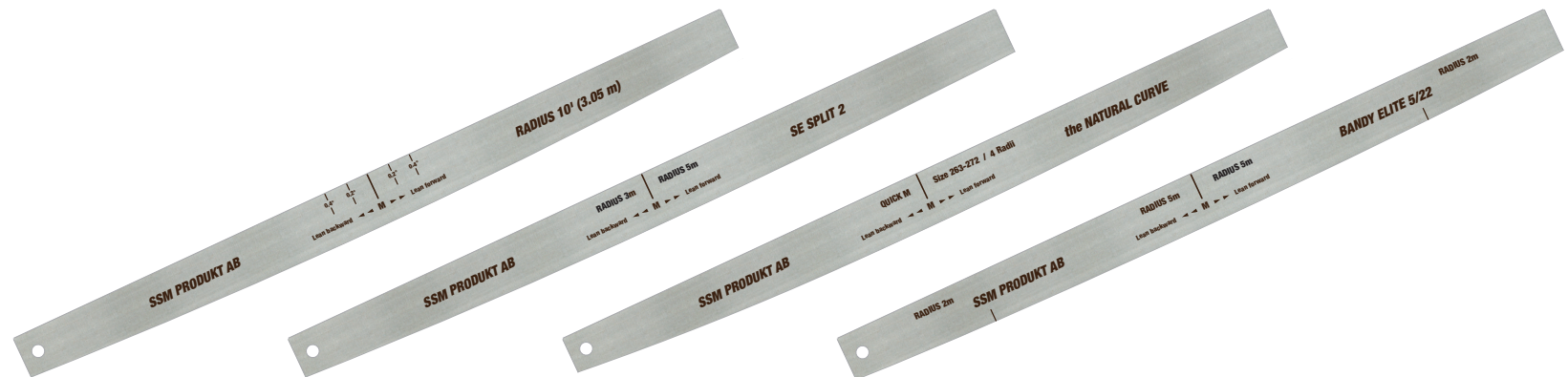

The lowest point on the skate when you are standing on the ice is called the “pivot point” or “balance point”. This point is normally in the middle of the skate blade.

**PIVOT**

It is also possible to move the pivot point of the skate blade forwards or backwards to alter the lie (pitch) of the skate (for example: moving the pivot point backwards toward the rear results in skate leaning (pitching) more forward.) You will then obtain a different angle towards the ice, the so called pitch; cases are: forward lie, neutral lie or backward lie.

**PITCH**

## EXHAUST SYSTEMS

When sharpening, you should always use a proper exhaust system attached to our machines to remove the discharges while keeping the sharpening area clean from dust. This is to avoid health issues and it also prolongs the lifetime of the skate sharpening machine. We recommend U-840 or NQS500. These dust extractors will fit all of our sharpening machines.

### FE-840

- Welding fume exhaust
- Filtration efficiency is at 99.7%
- Portable
- High quality!



### FE-324

- Replaceable filter for FE-840
- Treated with flame retardant!
- For approximately 2000 pairs of skates
- Same vacuum strength until the filter is full!

### NQS500

- Soot extraction system
- Strong motor (High/Low)
- Very quiet!
- Portable
- Filter treated with flame retardant!
- Regular filter bag not needed!



NM-11 is one of the most popular skate riveters in the world. The first version of it was released back in the seventies. Several thousands are by now used worldwide. A riveting machine is always a good investment. With it you can replace the plastic holder of the skate blade (or just replace damaged rivets).

The plastic holder can get broken, or it might just need to be straightened (if the skate blade is bent). It might also be that you want to replace it with a different size (serious athletes). All of this instead of having to buy a new pair of skates.

This riveting machine is primarily used for skates but some functions can also be used for boots, ski boots, roller blades or prosthetics. Included with the NM-11 are tools sets N-21 and N-E.

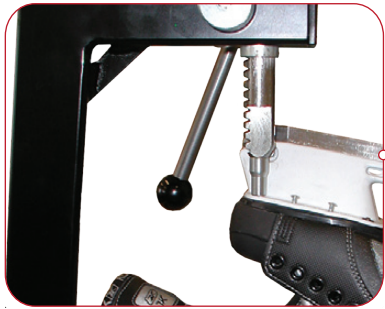

### VERY STRONG CONSTRUCTION

The body of the NM-11 is made in a way that it is really tough and stable. It will basically last forever if maintained correctly.

### LIGHT WEIGHT

The latest design of the NM-11 makes it easier to transport, weighing only 15 kg (33 lbs).

### POWERFUL

This machine will provide a force 23 times your own force when pressing down.

### EASY TO USE

It is easy to switch tools in the machine to perform requested duties.

# RIVETING ACCESSORIES

There are a number of different add-ons to put on your NM-11.

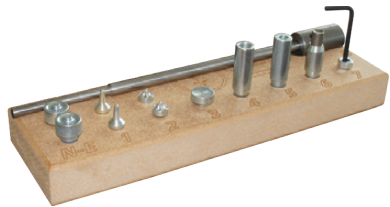

### Tool set **N-21**

- Remove tube rivets
- Attach tube rivets
- Attach copper rivets

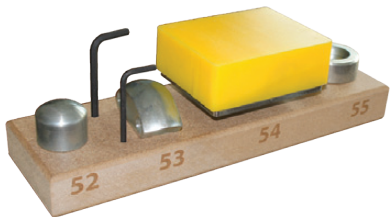

### Tool set **N-41**

- Stretch a skate
- Stretch a boot



### Tools **N-E**

- Attach eyelets



### Tools **N-RE**

- Remove eyelets



### Tool **V24**

- Attach shoe lace hooks
- (N-21 is also required)



### Tool **V26**

- Made for Marsblade
- Good for Rollerblades
- Attach rivets
- (N-21 is also required)



### Tube rivets **SN**

- Made of steel
- Length is: 8, 10, 12, 14, 16, 18, 20 or 22 mm
- 100/1000 pcs. in a package



### Copper rivets **KN**

- Rivets + washers
- Length is 26 or 32 mm
- 100 pcs. in a package



### Eyelets **EL**

- Professional model
- Black outside (height 7 mm)
- Grey inside (height 7 mm)
- 100 pcs. in a package



### Shoe lace hooks **FH**

- Professional model
- White or black
- 100 pcs. in a package



### Tool holder **V30**

- Another version of support
- In case you cannot reach with the regular support



### Tools **ORT201+301**

- Attach rivets
- For orthosis, THKAFO's and similar



### Tool holder **ORT100**

- Another version of support
- For orthosis

